









SAVE THESE INSTRUCTIONS
CORONADO HIGH DINING SWIVEL CHAIR
STYLE #: 61SRR2801COR
ASSEMBLE ON A FLAT, PROTECTED SURFACE.

PART LIST	FIGURE	QUANTITY	DESCRIPTION
A		1 PC	CHAIR FRAME
B		1 PC	ROTATION AXIS
C		1 PC	CHAIR BASE
D		4 PCS	BOLT (M8*35)
E		8 PCS	FLAT WASHER
F		4 PCS	SPRING WASHER
G		4 PCS	LOCKING NUT
H		2 PCS	WRENCH

CORONADO HIGH DINING SWIVEL CHAIR

STYLE #: 61SRR2801COR

ASSEMBLY INSTRUCTIONS (CONTINUED)

STEP 1

A. PLACE THE CHAIR FRAME (A) ON A FLAT SURFACE.

B. ATTACH THE ROTATION AXIS (B) TO CHAIR FRAME (A) WITH FLAT WASHER (E), BOLT (G), ANOTHER FLAT WASHER (E) AND SPRING WASHER (F) ON BOTTOM OF BOLT (D) AND SECURE WITH LOCKING NUT (G).

C. TIGHTEN COMPLETELY BY USING WRENCH (H).

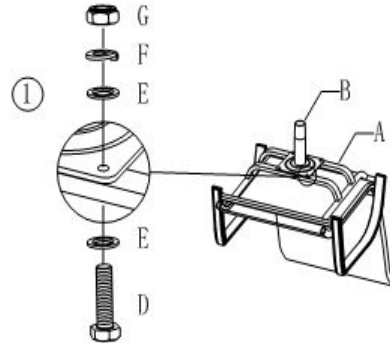

STEP 2

A. PLACE THE CHAIR BASE (B) ON A FLAT SURFACE.

B. INSERT THE CHAIR SEAT-BACK ASSEMBLY INTO THE CHAIR BASE (C).

C. PUSH DOWN FIRMLY TO "SNAP" INTO LOCKED POSITION.

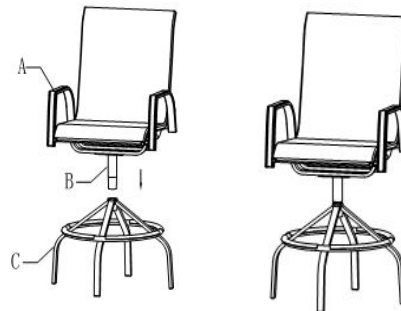

WEIGHT LIMIT

250 LBS

CARE AND CLEANING

IN ORDER TO PROLONG THE LIFE OF YOUR CHAIR, PLEASE STORE IN DRY SHELTERED PLACE WHEN NOT IN USE OR DURING INCLEMENT WEATHER.

WARRANTY

1 YEAR LIMITED WARRANTY FOR FRAME AND CUSHIONS.

CUSTOMER SERVICE: PLEASE NOTE - DO NOT RETURN THIS ITEM TO THE RETAILER.

CUSTOMER SERVICE HOT LINE: 1-866-905-4107

SERVICE HOURS: 11:30 A. M. to 8:00 P. M. EASTERN STANDARD TIME /8:30 A. M. to 5:00 P. M. PACIFIC STANDARD TIME

WEBSITE: WWW.YOTRIJOINT.COM

TO ASSIST YOU BETTER, PLEASE GATHER THE FOLLOWING INFORMATION BEFORE CALLING CUSTOMER SERVICE: PRODUCT NAME AND STYLE NUMBER, DESCRIPTION AND OR IMAGES OF THE ISSUE, ORIGINAL STORE PURCHASE RECEIPT.