

















SAVE THESE INSTRUCTIONS
CLAREMONT HIGH DINING SWIVEL CHAIR
STYLE #: 61SRR2801CLR
ASSEMBLE ON A FLAT, PROTECTED SURFACE.

PART LIST	FIGURE	QUANTITY	DESCRIPTION
A		1 PC	RIGHT ARM
B		1 PC	LEFT ARM
C		1 PC	BACK
D		1 PC	SEAT
E		1 PC	ROTATION AXIS
F		1 PC	BASE
G		10 + 1 PCS	SHORT BOLT (M6*15)
H		4 + 1 PCS	LONG BOLT (M8*35)
I		10 + 1 PCS	FLAT WASHER
J		8 + 1 PCS	FLAT WASHER
K		4 + 1 PCS	SPRING WASHER
L		4 + 1 PCS	LOCKING NUT
M		1 PC	ALLEN WRENCH
N		2 PCS	WRENCH
O		1 PC	SEAT CUSHION
P		1 PC	BACK CUSHION

**CLAREMONT HIGH DINING SWIVEL CHAIR
 STYLE #: 61SRR2801CLR
 ASSEMBLY INSTRUCTIONS (CONTINUED)**

STEP 1

- A. PLACE SEAT (D) ON A FLAT, PROTECTED SURFACE.
- B. CONNECT RIGHT ARM (A) TO SEAT (D) WITH FLAT WASHER (I) AND SHORT BOLT (G) USING ALLEN WRENCH (M). DO NOT TIGHTEN COMPLETELY.

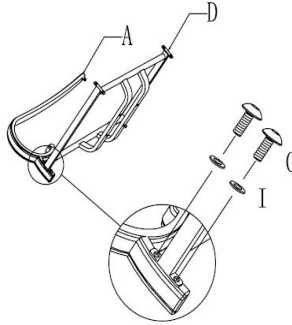

STEP 2

- A. TURN THE CHAIR (IF NEEDED).
- B. CONNECT BACK (C) TO RIGHT ARM (A) WITH FLAT WASHER (I) AND BOLT (G) USING ALLEN WRENCH (M). DO NOT TIGHTEN COMPLETELY.
- C. CONNECT BACK (C) TO SEAT (D) WITH FLAT WASHER (I) AND BOLT (G) USING ALLEN WRENCH (M). DO NOT TIGHTEN COMPLETELY.

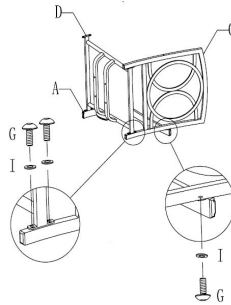

STEP 3

- A. TURN THE CHAIR (IF NEEDED).
- B. CONNECT BACK (C) TO LEFT ARM (B) WITH FLAT WASHER (I) AND BOLT (G) USING ALLEN WRENCH (M). DO NOT TIGHTEN COMPLETELY.
- C. CONNECT SEAT (D) TO LEFT ARM (B) WITH FLAT WASHER (I) AND BOLT (G) USING ALLEN WRENCH (M). DO NOT TIGHTEN COMPLETELY.

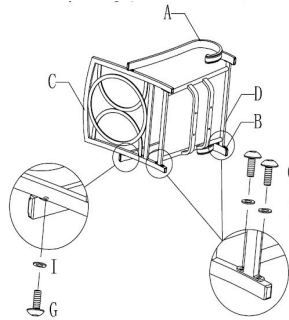

STEP 4

- A. TURN CHAIR ASSEMBLY FACE DOWN ON PROTECTED SURFACE.
- B. CONNECT THE ROTATION AXIS (E) TO THE SEAT-BOTTOM WITH FLAT WASHER (J), SPRING WASHER (K), LOCKING NUT (L) AND LONG BOLT (H) FULLY TIGHTEN LOCK NUTS (L) WITH WRENCH (N).

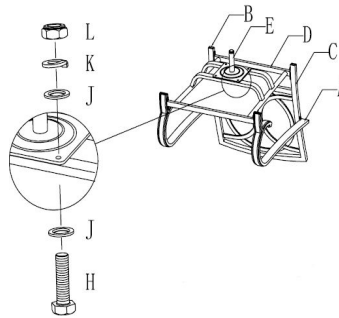

CLAREMONT HIGH DINING SWIVEL CHAIR
STYLE #: 61SRR2801CLR
ASSEMBLY INSTRUCTIONS (CONTINUED)

STEP 5

- A. INSERT THE CHAIR ASSEMBLY INTO THE BASE (F).
- B. PUSH DOWN FIRMLY TO "SNAP" INTO LOCKED POSITION.

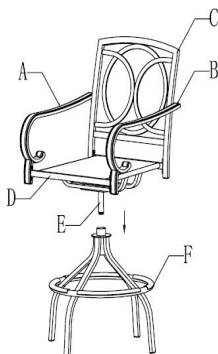

STEP 6

- A. TIGHTEN ALL BOLTS (G+H) SECURELY USING WRENCH (M) & (N).
- B. INSTALL SEAT CUSHION (O) AND BACK CUSHION (P).
- C. RETAIN WRENCH (M) & (N) FOR USE TO TIGHTEN BOLTS PERIODICALLY OR AS NEEDED.

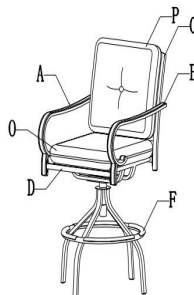

WEIGHT LIMIT
250 LBS

CARE AND CLEANING

IN ORDER TO PROLONG THE LIFE OF YOUR CHAIR, PLEASE STORE IN DRY SHELTERED PLACE WHEN NOT IN USE OR DURING INCLEMENT WEATHER.

WARRANTY

1 YEAR LIMITED WARRANTY FOR FRAME.

CUSTOMER SERVICE: PLEASE NOTE - DO NOT RETURN THIS ITEM TO THE RETAILER.

CUSTOMER SERVICE HOT LINE: 1-866-905-4107

SERVICE HOURS: 11:30 A. M. to 8:00 P. M. EASTERN STANDARD TIME /8:30 A. M. to 5:00 P. M. PACIFIC STANDARD TIME

WEBSITE: WWW.YOTRJOINT.COM

TO ASSIST YOU BETTER, PLEASE GATHER THE FOLLOWING INFORMATION BEFORE CALLING CUSTOMER SERVICE: PRODUCT NAME AND STYLE NUMBER, DESCRIPTION AND OR IMAGES OF THE ISSUE, ORIGINAL STORE PURCHASE RECEIPT.